



[www.bvl-elevations.com](http://www.bvl-elevations.com)



## **MECHANICAL GARAGE**

**WE PLAN, DESIGN,  
MANUFACTURE  
AND INSTALL**

---



## BVL ELEVATIONS PROFILE

**BVL ELEVATIONS** is one of the earliest professional mechanical parking solution providers in CHINA. We are committed to provide the most suitable and cost effective parking solutions to our customers all over the world.

Hydro-Park is a subsidiary company and sub-brand built by **BVL** for high-end mechanical simple parking equipment. We develop, design and manufacture mechanical parking equipment with our own advanced technology and kept consistent high quality.

Our target is to become world class manufacturer with following competitive advantages:

- Advanced Technology
- Precise Manufacture Processing
- Strong Service Support
- Customer Oriented

For all the people who work in the mechanical parking business, if you are looking for a reliable partner in CHINA, Mutrade is the one company you can not miss!



[www.bvl-elevations.com](http://www.bvl-elevations.com)

PRODUCT RANGE

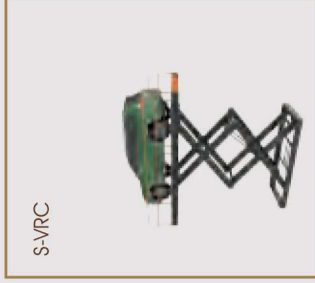
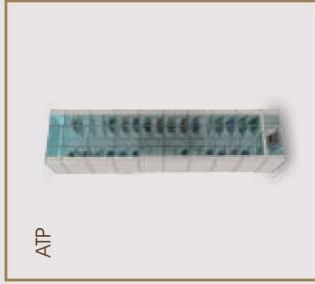



**Certified by**



## Two Post Parking Lift Hydro-Park 1127

Lifting capacity	2700kg/6000lbs
Lifting height	2100mm/83inches
Usable platform width	2100mm/83inches
Power Unit	3Kw hydraulic pump
Available voltage of power supply	100V-450V, 1 or 3 Phase, 50/60Hz
Operation mode	Key switch
Operation voltage	24V
Safety lock	Dynamic anti-falling lock
Lock release	Electric auto release
Rising/descending speed	<40s
Finishing	Powder coating

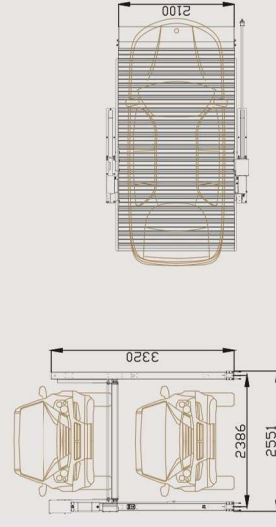
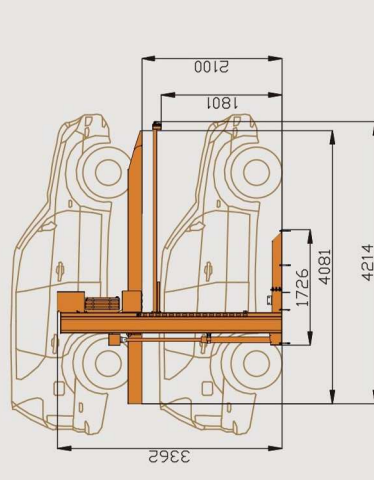

- 2700kg capacity for most types of vehicles
- Self-standing and self-support structure
- Symmetrical designed column
- Middle post sharing feature saves cost and space
- Galvanized and corrugated platform guarantee safety and long lifetime
- Anti-slip corrugated deck protect both vehicle and driver from possible slip and damage but still high-heel shoe friendly
- Single hydraulic lifting cylinder with chain as driven system makes movement faster and more smooth
- Individual hydraulic power pack and 24V safety control panel

- Synchronization chain assuring the lifting platform balance
- Electric key switch for security and safety
- Unique "LOCK DOWN" button for platform sitting on locking tab to protect cylinder
- Automatic shut-off once operator releases the key switch
- Dynamic mechanical locks as anti-falling device hold the platform in place all the way
- Manual lock release available in case electricity failure
- Platform can be stopped at different heights to fit for various vehicles and ceiling heights
- Photozell sensor detection could stop operation if any vehicle under platform
- Hydraulic overloading protection



## Two Post Parking Lift Hydro-Park 1123

Lifting capacity	2300kg/5000lbs
Lifting height	2100mm/83inches
Usable platform width	2100mm/83inches
Power Unit	2.2Kw hydraulic pump
Available voltage of power supply	100V-450V, 1 or 3 Phase, 50/60Hz
Operation mode	Key switch
Operation voltage	24V
Safety lock	Dynamic anti-falling lock
Lock release	Electric auto release
Rising/descending speed	<40s
Finishing	Powder coating

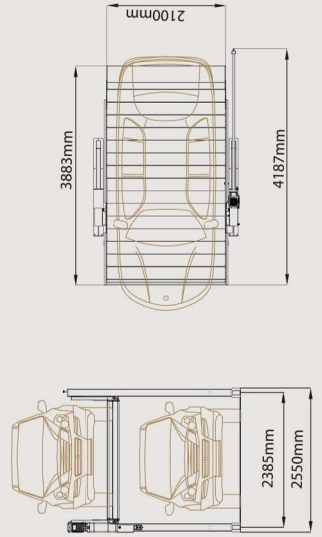
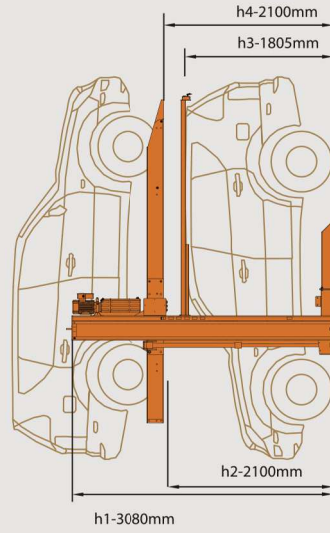

- 2300kg capacity for most types of vehicles
- Self-standing and self-support structure
- Symmetrical designed column
- Middle post sharing feature saves cost and space
- Galvanized and corrugated platform guarantee safety and long lifetime
- Anti-slip corrugated deck protect both vehicle and driver from possible slip and damage but still high-heel shoe friendly
- Single hydraulic lifting cylinder with chain as driven system makes movement faster and more smooth
- Individual hydraulic power pack and 24V safety control panel
- Synchronization chain assuring the lifting platform balance

- Electric key switch for security and safety
- Unique "LOCK DOWN" button for platform sitting on locking tab to protect cylinder
- Automatic shut-off once operator releases the key switch
- Dynamic mechanical locks as anti-falling device hold the platform in place all the way
- Manual lock release available in case electricity failure
- Platform can be stopped at different heights to fit for various vehicles and ceiling heights
- Photocell sensor detection could stop operation if any vehicle under platform
- Hydraulic overloading protection

Certified by



www.bvl-elevations.com



- 3000kg capacity makes it possible for all SUVs
- Commercial grade design
- 2150mm usable platform width make it much easier for parking and retrieve
- Galvanized and corrugated platform guarantee safety and long lifetime
- Anti-slip corrugated deck protect both vehicle and driver from possible slip and damage but still high-heel shoe friendly
- Hydraulic cylinder and chain drive system for smooth operation
- The pole with piston is chorming to anti-corrode to ensure its long using life

- Individual hydraulic power pack and control panel, both covered in the back of platform for security and rainproof
- Self-standing and self-support structure
- Can be relocated
- Electric key switch for security and safety
- A new "LOCK DOWN" button for platform sitting on locking tab to protect cylinder
- Automatic shut-off if operator releases the key switch
- Dynamic mechanical locks as "all the way" anti-falling device hold the platform in place
- Platform can be stopped at different heights to fit for various vehicles and ceiling heights
- Hydraulic overloading protection

## Four Post Parking Lift Hydro-Park 2130

Lifting capacity	3000kg/6600lbs
Lifting height	2100mm/83inches
Usable platform width	2140mm/84inches
Power Unit	2.2Kw hydraulic pump
Available voltage of power supply	100V-450V, 1 or 3 Phase, 50/60Hz
Operation mode	Key switch
Operation voltage	24V
Safety lock	Dynamic anti-falling lock
Lock release	Electric auto release
Rising/descending speed	<40s
Finishing	Powder coating

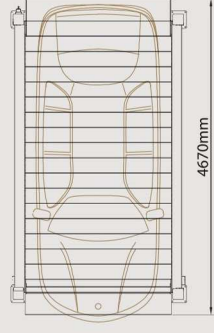
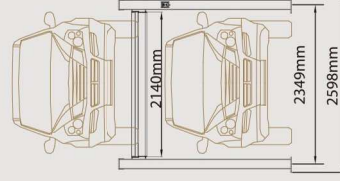
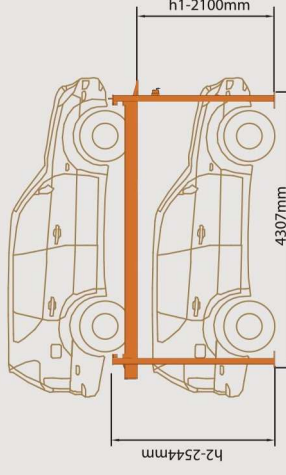



## Four Post Parking Lift Hydro-Park 2236

Lifting capacity	3600kg/8000lbs
Lifting height	1800mm/71inches
Usable platform width	2100mm/83inches
Power Unit	2.2Kw hydraulic pump
Available voltage of power supply	100V-450V, 1 or 3 Phase, 50/60Hz
Operation mode	Key switch
Operation voltage	24V
Safety lock	Dynamic anti-falling lock
Lock release	Electric auto release
Rising/descending speed	<55s
Finishing	Powder coating

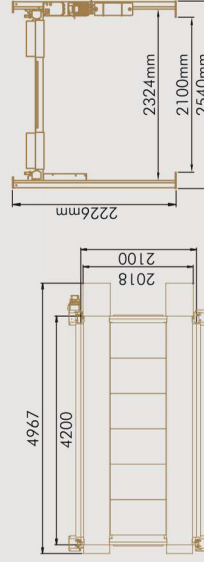
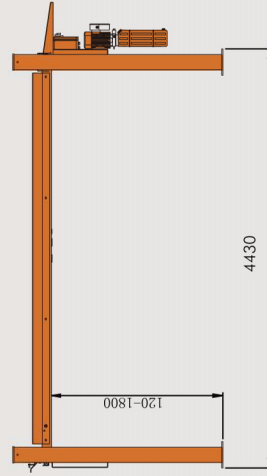

-3600kg capacity makes it possible for heavy duty vehicles.  
-Commercial grade design

-2100mm usable platform width makes it much easier for parking and retrieve.

-Unique mechanical detection will stop platform at once in case steel rope is loosen or cut off.

-Anti-slip diamond plates as drive way

-Lateral protection plates at two sides of platform will prevent vehicles going out.

-Electric key switch control for security and safety

-Automatic shut-off if operator releases the key switch

-LOCK DOWN button makes platform sit on locking

tabs to increase safety and rest the cylinder for longer lifetime.

-Hydraulic cylinder and steel rope drive system for smooth operation

-The pole with piston is chroming to anti-corrode to ensure its long using life

-Self-standing and self-support structure

-Dynamic mechanical locks as anti-falling device hold the platform in place

-Platform can be stopped at different heights to fit for various vehicles and ceiling heights

-Hydraulic overloading protection



## Four Post Stacker Parking Lift Hydro-Park 3130/3230



Available vehicle parking	3 cars/4cars
Lifting speed	<90s/ <150s
Rated capacity	3000kg
Drive-through width	2050mm
Available vehicle height	2000mm
Operation mode	Key switch
Lock release	Manual with handle
Drive mode	Hydraulic cylinder + steel ropes
Pump power	7.5Kw
Finishing	Powder coating
Control voltage	24V
Power supply	208 – 450V, 3 phase, 50/60Hz

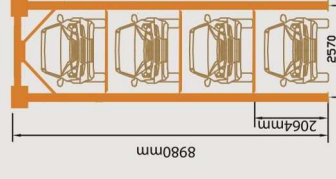
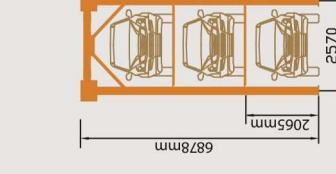

- 3000kg capacity for both SUV and sedan
- Commercial grade design, suitable for both car parking and storage
- Four levels maximum
- One complete steel plate design for platform
- Single hydraulic cylinder with steel ropes drive
- Central hydraulic power pack and individual control panel
- Self-standing and self-support structure
- Middle post sharing feature save cost and space
- Electric key switch for security and safety
- Automatic shut-off if operator releases the key switch
- Mechanical lock on cylinder as anti-falling safety device
- Hydraulic overload protection

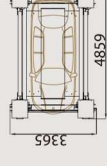
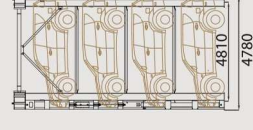
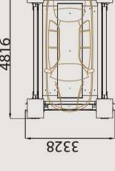
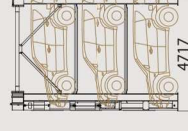

## Two Post Tilting Parking Lift TPTP-2

Vehicle size	5000mmX1850mmX1550mm
Vehicle weight	≤2000Kg
Lifting height	1600mm
Lock mode	Position lock
Drive mode	Hydraulic
Surface treatment	Powder coating
Control power	24V
Lifting time	24S
Lowering time	24S
Voltage	380V/220V
Motor power	2.2kw

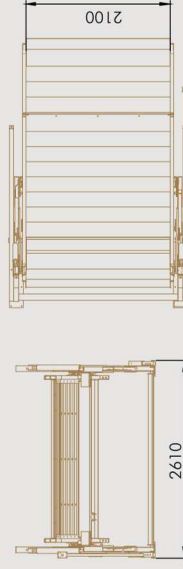
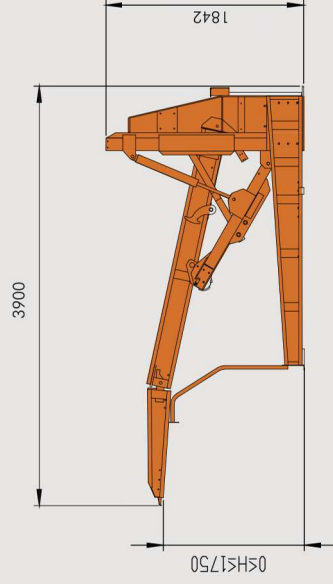

- Designed for low ceiling height
- 2000kg capacity, suitable for sedan only
- Galvanized platform with wave plate for better parking
- 10 degree tilting platform
- Dual hydraulic lifting cylinders direct drive
- Individual hydraulic power pack and panel
- Self-standing and self-support structure
- Can be moved or relocated
- Electric key switch for security and safety
- Automatic shut-off if operator release the key switch

- Both electrical and manual lock release for your choice
- Maximum lifting height adjustable to fit for different ceiling height
- Mechanical anti-falling lock on top position
- Hydraulic overload protection



## Pit Two Post Parking Lift PTPP-2

Lifting capacity	2000kg/4400lbs
Lifting height	1900mm/75inches
Usable platform width	2100mm/83inches
Power Unit	3Kw hydraulic pump
Available voltage of power supply	100V-450V, 1 or 3 Phase, 50/60Hz
Operation mode	Key switch
Operation voltage	24V
Safety lock	Dynamic anti-falling lock
Lock release	Electric auto release
Rising/descending speed	<55s
Finishing	Powder coating

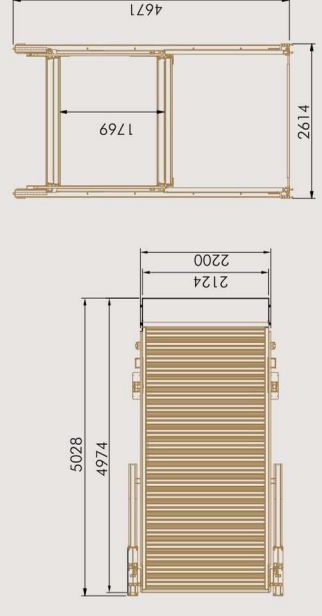
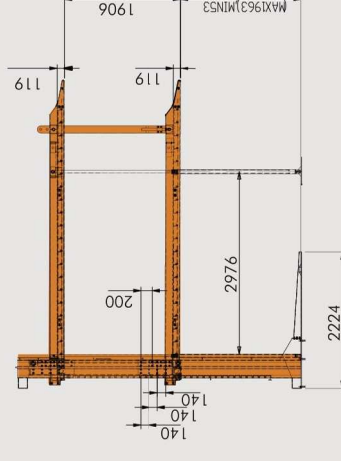

- New commercial grade design released to the market
- Galvanized platform with wave plate for better parking
- Dual master & slave hydraulic lifting cylinders direct drive
- Individual hydraulic power pack and control panel
- Pit and back wall needed for structure supporting
- 2000kg capacity for sedan only
- Middle post sharing feature save cost and space
- Electric key switch for security and safety
- Automatic shut-off if operator releases the key switch
- Balance chain synchronization
- Single & double stacker for your choice
- Hydraulic overload protection



## Pit Four Post Parking Lift PFPP

Parking vehicle	2 / 3
Motor power	2.2kw /3.7kw
Lifting capacity	2000kg/space
Usable Vehicle Size (mm, LxWxH)	5000x1850x1550
Finishing	Powder coating
Lock release	Auto
Operation	Button / IC card / Manual
Power supply	380v, 3P, 50/60Hz

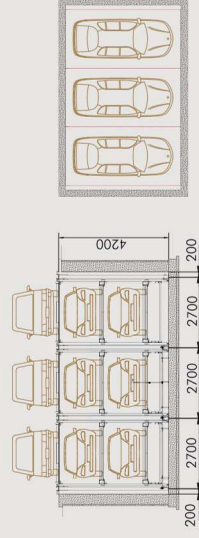
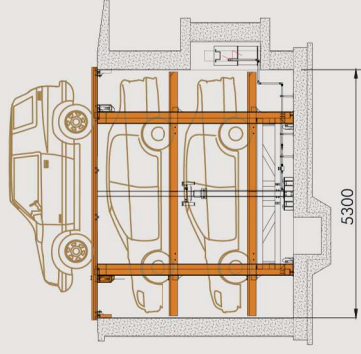

- Both commercial use and home use suitable
- Three levels underground maximum
- Galvanized platform with wave plate for better parking
- Both hydraulic drive and motor drive available
- Central hydraulic power pack and control panel, with PLC control system inside
- Code, IC Card and manual operation available
- 2000kg capacity for sedan only
- Middle post sharing feature save cost and space
- Anti-falling ladder protection
- Hydraulic overload protection

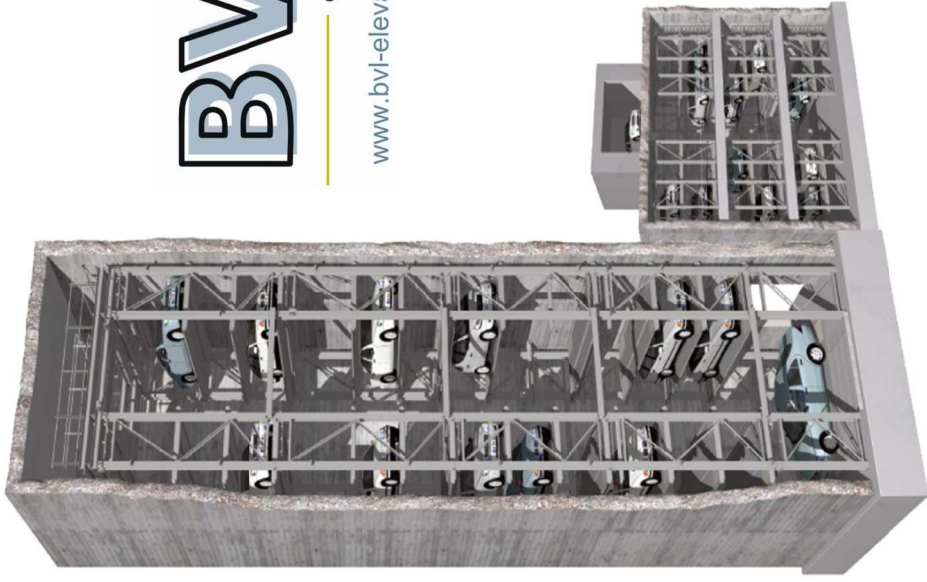

[www.bvl-elevations.com](http://www.bvl-elevations.com)

## Bi-Directional Parking System BDP Series

Levels	2 - 15
Available Vehicle Size	5000mm x 1850mm x 1550mm (LxWxH) *can be customized to fit for SUV
Drive mode	Hydraulic Cylinder + Steel Cable
Lifting capacity	2000kg *can be customized to fit for SUV
Hydraulic pump power	4Kw 11Kw 15Kw
Lifting speed	8-12m/min 15-18m/min 22-28m/min
Sliding speed	7.5m/min
Control	Omron PLC system
Operation	Button, IC cards, or manual, with LED display
Finishing	Sand blasting, Zinc spray, then Surface painting for protection

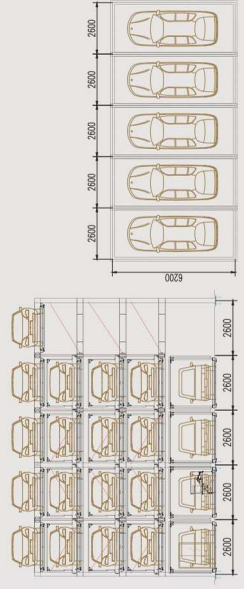
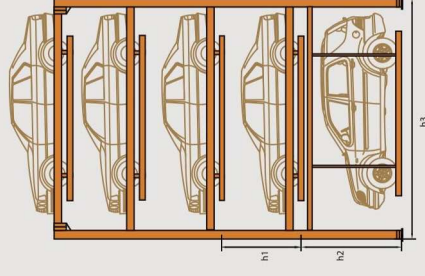

- Commercial grade design
- Galvanized platform with wave plate for better parking
- 15 levels above ground for all sedan maximum, or 5 levels above ground for all SUV maximum
- Can be mixed with 3 levels underground
- Hydraulic cylinder with steel rope drive
- Fast lifting and descending speed
- Patented hydraulic variable frequency speed control technology to smoothly approaching ground
- Central hydraulic power pack and control panel, with PLC control system inside
- Code, IC Card and manual operation available
- 2000kg capacity for sedan system, and 2500kg capacity for SUV system
- Patented anti-falling frame protection
- Hydraulic overload protection

## Automatic Tower Parking System ATP series

Levels of System	35 levels max	
Car Size(L×W×H)	≤5300mm×1900mm×1550mm	
Car Weight	2200kg	
Mode of Operation	Auto/Manual	
Speed of Operation	Lift	60-120m/min
	Slide	7.5m/min
	Turning	4rpm
	Lift	30kw
	Slide	0.2kw
	Turning	1.5kw
Motor power		

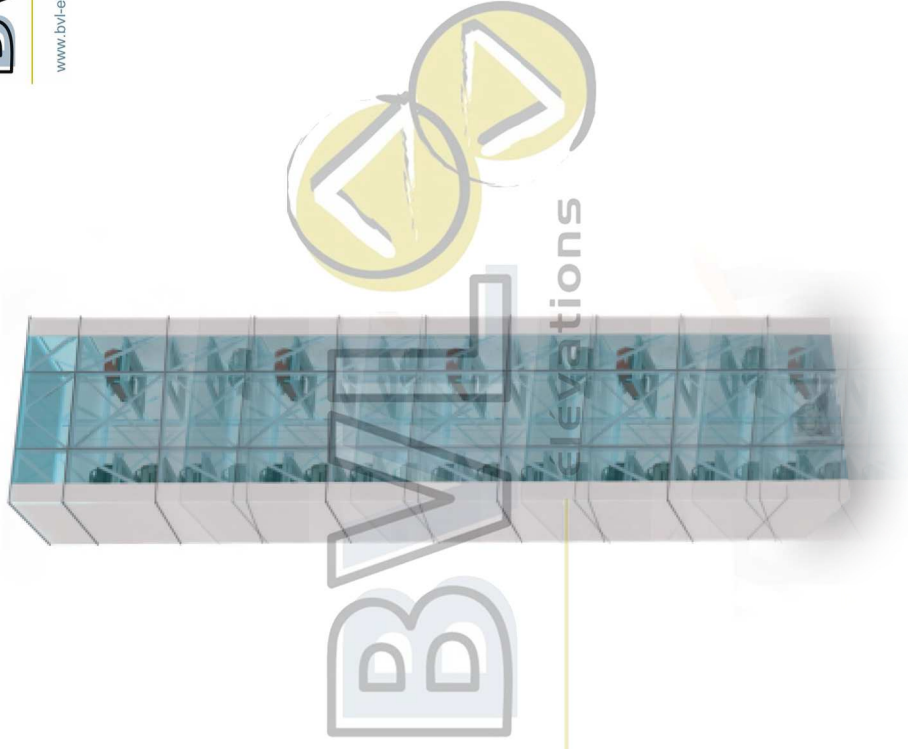
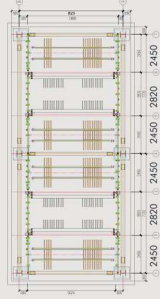
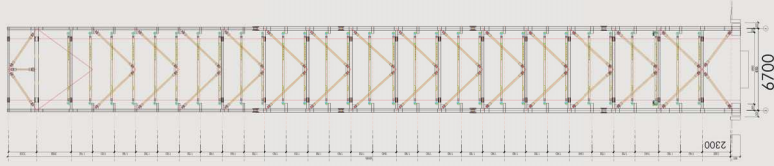

- New developed high levels commercial parking design
- 35 levels above ground maximum
- Comb pallet for better vehicle tires protection
- Both hydraulic cylinder and traction drive available for your choice
- Fast lifting and descending speed
- Patented hydraulic variable frequency speed control technology to smoothly approaching ground
- Central hydraulic power pack and control panel, with PLC control system inside
- Code, IC Card and manual operation available
- 2000kg capacity as standard, and 2500kg capacity available
- Hydraulic overload protection



## Four Post Vertical Reciprocating Conveyor FP-VRC

Lifting capacity	2,000-5,000 kg
Lifting height	2,000-12,000mm
Platform length	2000mm-6000mm
Platform width	2000mm-5000mm
Platform material	Diamond steel sheet (standard) / 4mm Aluminum steel sheet (optional)
No. of level	according to your requirement
Drive mode	Hydraulic(cylinder with double steel chains)
Operation	button switch (standard) / remote controller (optional)
Power pack	4 kw hydraulic power pump
Lifting speed	4m/min
Safety devices	Mechanical anti-falling lock
Finishing	Paint spray
Color	according to your requirement

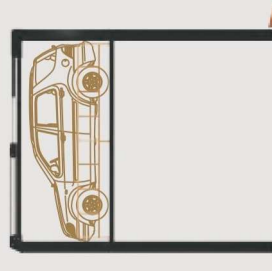

- VRC (Vertical Reciprocating Conveyor) is a transportation conveyor moving car from one floor to another, it is a highly customized product, which could be customized according to customer's different requirements from lifting height, lifting capacity to platform size!
- FPVRC is a kind of car or goods lift, and industry use vertical table lift
- Self-standing and self-support structure
- Hydraulic cylinder + steel chains drive system
- High precision and stable hydraulic drive system

- Automatic shut-off if operator releases the button switch
- Double chain design for higher safety
- High density chains with longer service life
- Remote control is optional
- Top quality diamond steel plate
- Hydraulic overloading protection available

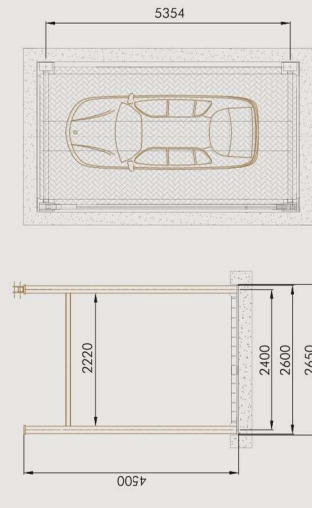

## Scissor Vertical Reciprocating Conveyor S-VRC

Lifting capacity	2,000-10,000 kg
Lifting height	2,000-15,000mm
Platform length	2000mm-6000mm
Platform width	2000mm-5000mm
Platform material	Diamond steel sheet (standard) / 4mm Aluminum steel sheet (optional)
No. of level	according to your requirement
Drive mode	Hydraulic(cylinder with double steel chains)
Operation	button switch (standard) / remote controller (optional)
Power pack	4 kw hydraulic power pump
Lifting speed	4m/min
Safety devices	Mechanical anti-falling lock
Finishing	Paint spray
Color	according to your requirement

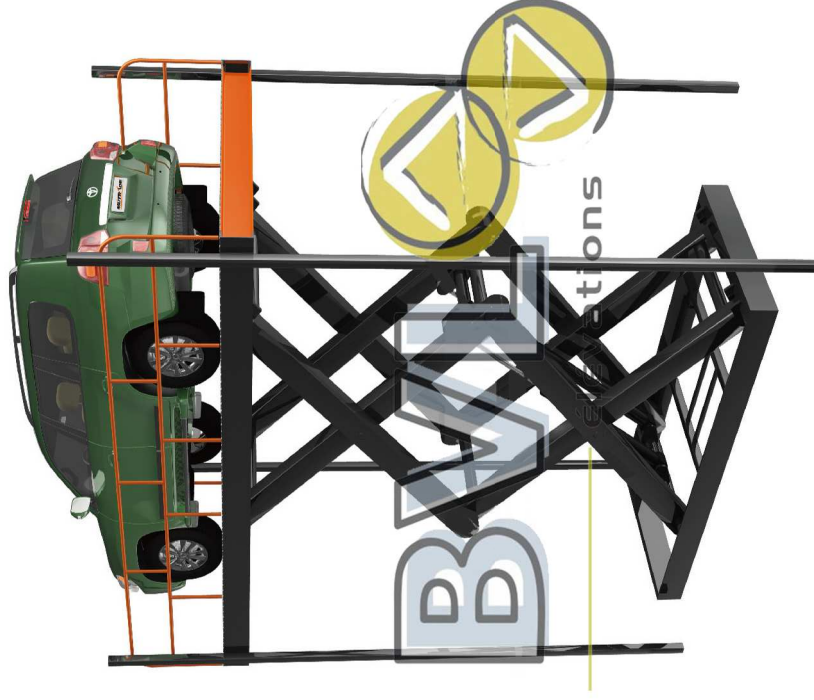
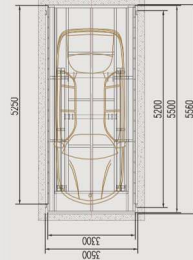
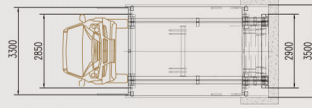
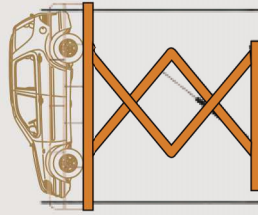

VRC (Vertical Reciprocating Conveyor) is a transportation conveyor moving car from one floor to another, it is a highly customized product, which could be customized according to customer's different requirements from lifting height, lifting capacity to platform size!

- S-VRC is a kind of car or goods lift, and industry use vertical table lift
- A foundation pit is needed for S-VRC
- The ground will be flat after S-VRC descend to bottom position

- Hydraulic cylinder direct drive system
- Double cylinder design
- High precision and stable hydraulic drive system
- Automatic shut-off if operator releases the button switch
- Small space occupation
- Pre-assembled structure makes easier installation
- Remote control is optional
- Double levels of platforms are available to have more parking
- Top quality diamond steel plate
- Hydraulic overloading protection available

# Car Turn Table CTT

Drive mode	Electric motor
Diameter	1.2-3.5m *can be customized according to customers' requirements
Loading capacity	1-20ton *can be customized according to customers' requirements
Motor power	0.75kw *can be customized according to customers' requirements
Voltage	380v, 50hz, 3P *can be customized according to customers' requirements
Turning speed	0.2-2rpm
Turning angle	360 any direction
Min. height	180/320mm
Finishing	Paint-spray
Color	Customized
Coverage of platform	Diamond plate / Aluminium alloy plate / Stainless steel plate / Acrylic plate *can be customized according to customers' requirements
Operation	Button/ remote control/PLC* can be customized according to customers' requirements
Metal processing	Laser cutting

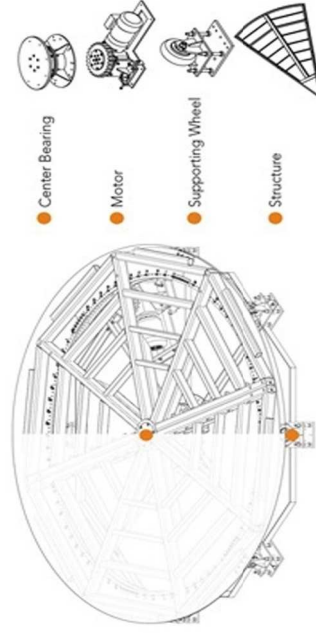
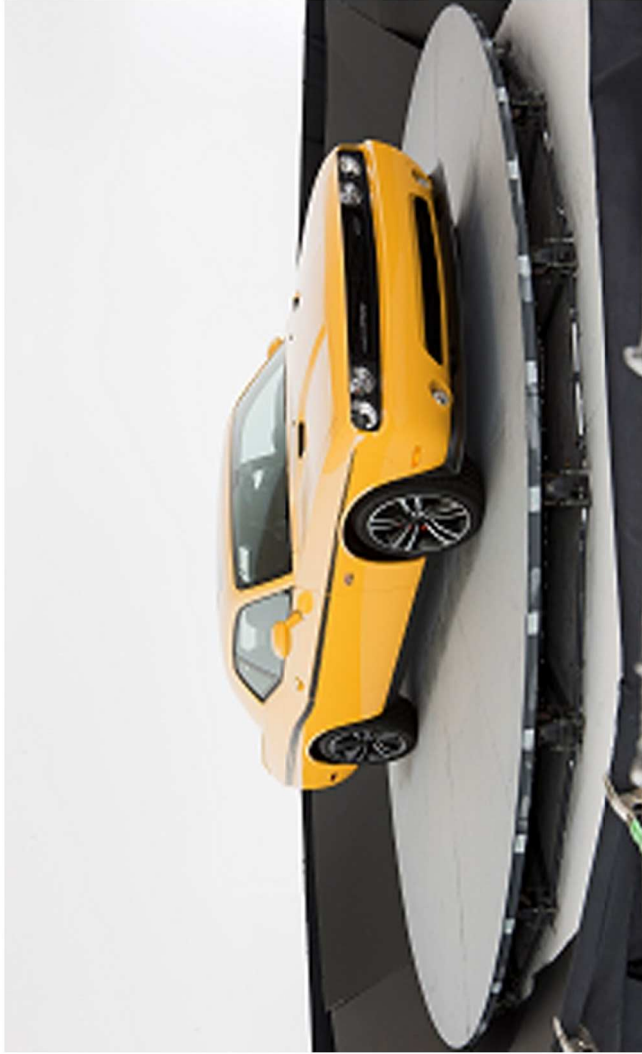
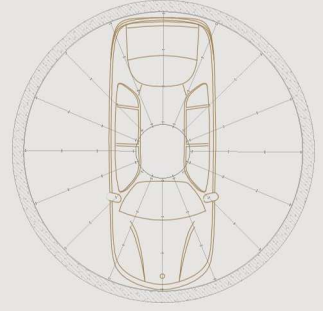
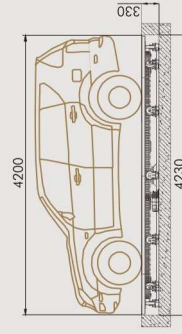

[www.bvl-elevations.com](http://www.bvl-elevations.com)

- We customize car turntable for you under your specification.
- Diameter of the table (form 1.2 to 3.5 meters)
- Turning speed and angle (0.2-2 rpm)
- Capacity form 1 ton to 20 tons
- Variety surface option



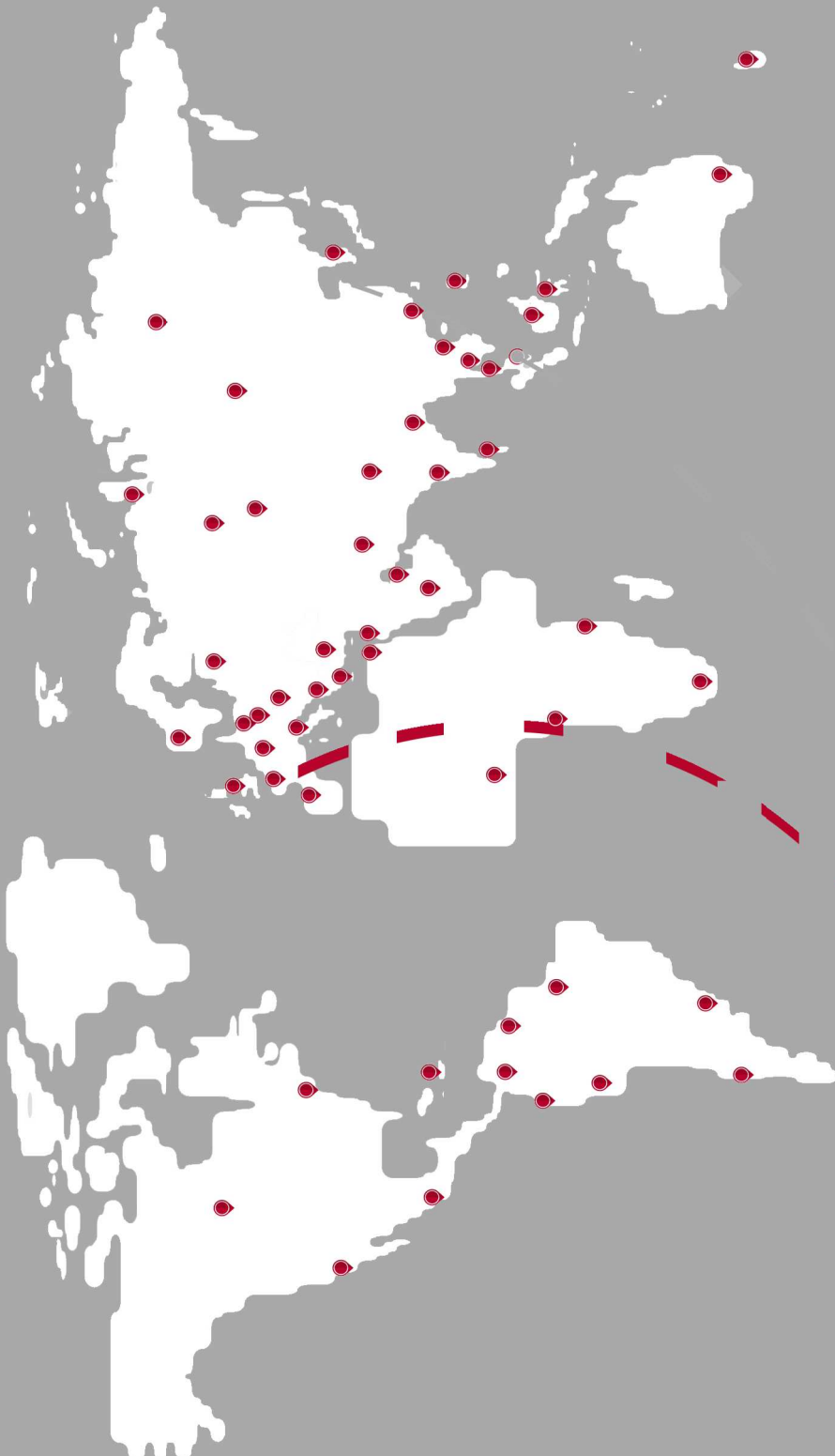

**BVL ELEVATIONS**  
115 Avenue des chênes Rouges  
30100 ALES  
04 66 56 67 43  
[contact@bvl-elevations.com](mailto:contact@bvl-elevations.com)

